

PHOTO COPY SERVICE  
UNIVERSITY OF MORATUWA

PHOTO COPY SERVICE  
UNIVERSITY OF MORATUWA  
2530

**DEPARTMENT OF ARCHITECTURE  
FACULTY OF ARCHITECTURE - UNIVERSITY OF MORATUWA**

**Aptitude Test for the Admission to the Bachelor of Architecture (B Arch) Degree &  
Bachelor of Landscape Architecture (B L A) Degree - 2013**

(Three Hours) - 03 hrs

Instruction to candidates

1. Answer all THREE questions
2. All questions to be answered in ENGLISH only
3. All questions to be answered on the question paper itself
4. Write your index number in all answer sheets
5. Question No 3 will be given **one hour** before the closing time.
6. **STOP** when instructed and place paper face down on your desks

**QUESTION ONE (40 MARKS)**

Given are drawings of four objects in Two Dimensions.

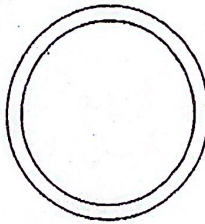

.....

.....

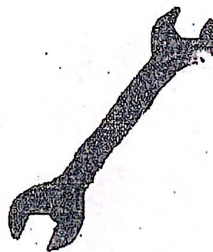
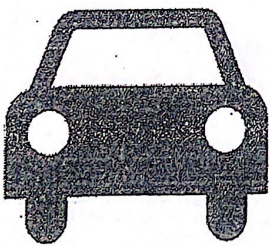

.....

.....

1.1 Identify all four objects. (4 MARKS)

INDEX NO: .....





INDEX NO: \_\_\_\_\_

1.2. Re-draw each of the four objects in Three Dimensions (3D) (16 MARKS)



UNIVERSITY OF MORATUWA  
INSTITUTIONAL DEVELOPMENT  
AND RESEARCH DEPARTMENT

INDEX NO: \_\_\_\_\_

1.3 Select three from the previous four objects and make an expressive composition.  
(20 MARKS)



INDEX NO:

**QUESTION TWO (30 MARKS)**

In each of the following use your imagination to create an original sketch or drawing incorporating the lines already provided. Create a story with the four sketches / drawings.

Give a title.

The drawings you create can for example; express movement or action, incorporate humour / emotion / fantasy, be unusual in their visualisation etc.....

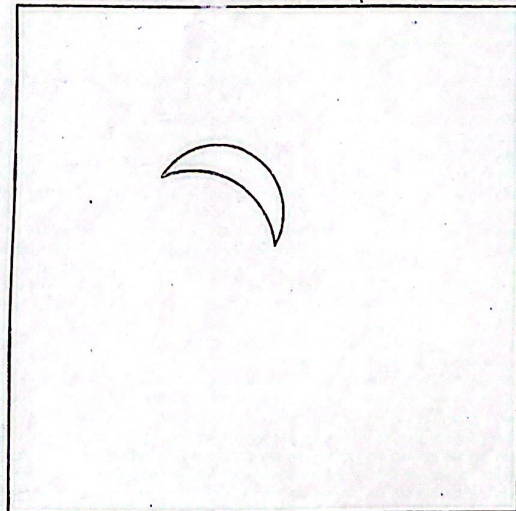
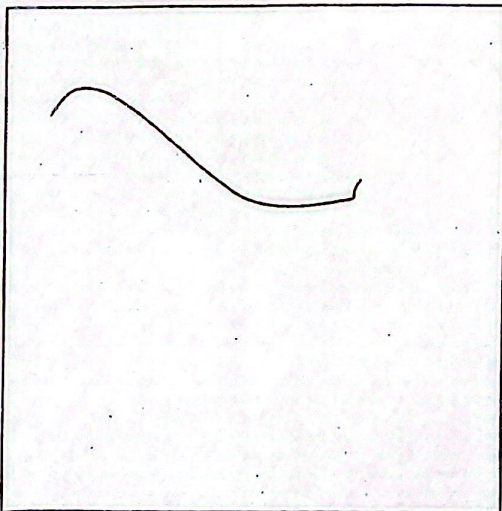
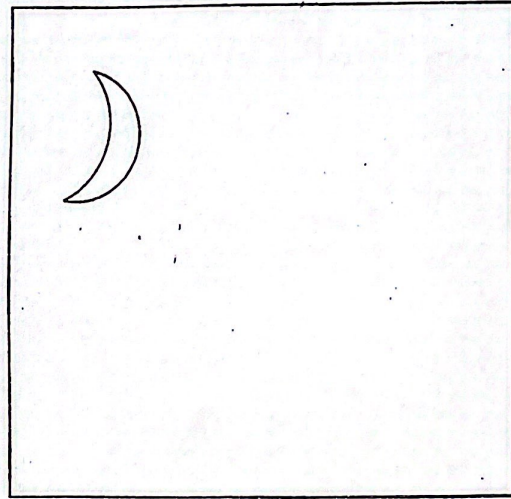
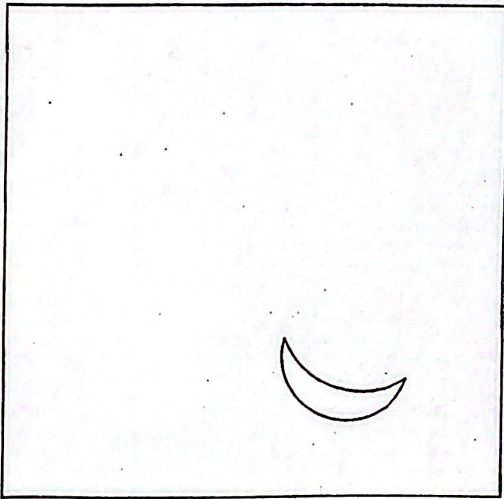



**QUESTION THREE – 60 MINUTES (30 MARKS)**

- o All questions need to be answered by **circling** the appropriate answer on the question paper itself
- o **STOP** when instructed and place paper face down on your desks

3.1

Identify the shape that is identical to the one on the left.  
There maybe more than one which is exactly the same. Circle the correct answer/s.

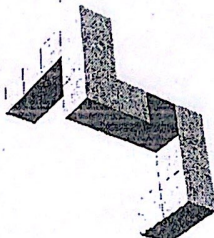
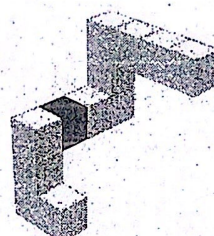
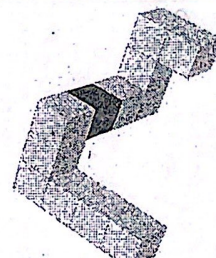
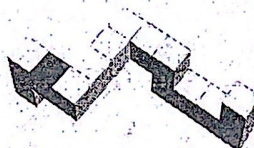
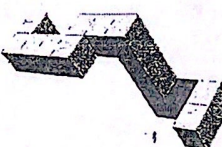
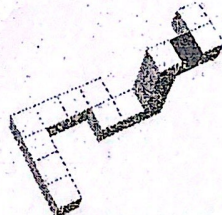
01			
02			



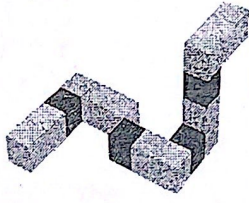
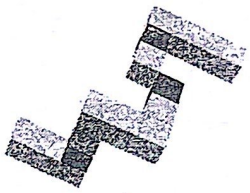
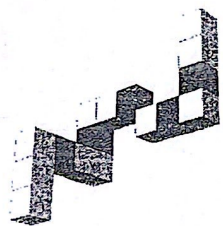
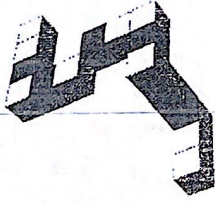
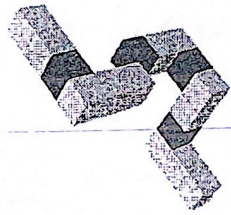
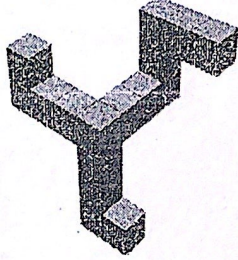
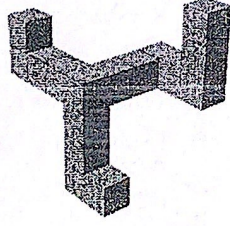
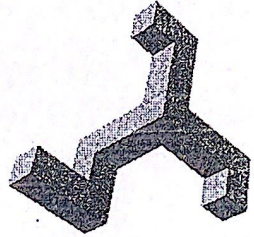
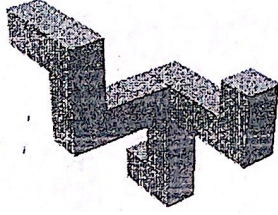
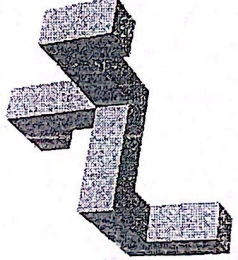
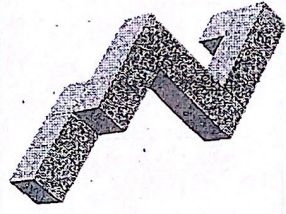
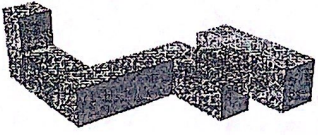
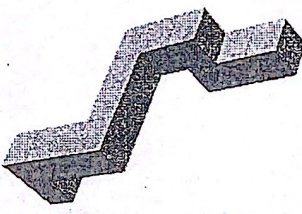
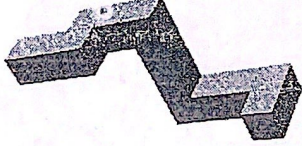
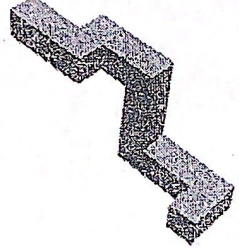

INDEX NO:

03			  
04		 	 
05		 	 







06	A 3D block letter 'H' with a horizontal bar at the top and two vertical bars on the sides.	Four 3D block letters arranged in two rows. The top row contains 'H' and 'I'. The bottom row contains 'J' and 'K'. Each letter is a solid 3D shape with a consistent thickness and depth.
07	A 3D block letter 'U' with a horizontal bar at the top and two vertical bars on the sides.	Four 3D block letters arranged in two rows. The top row contains 'U' and 'V'. The bottom row contains 'W' and 'X'. Each letter is a solid 3D shape with a consistent thickness and depth.
08	A 3D block letter 'L' with a horizontal bar at the top and a vertical bar on the right side.	Four 3D block letters arranged in two rows. The top row contains 'L', 'M', and 'N'. The bottom row contains 'O' and 'P'. Each letter is a solid 3D shape with a consistent thickness and depth.





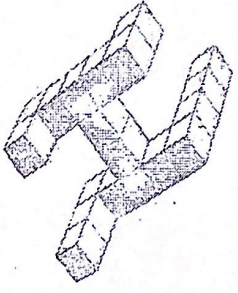
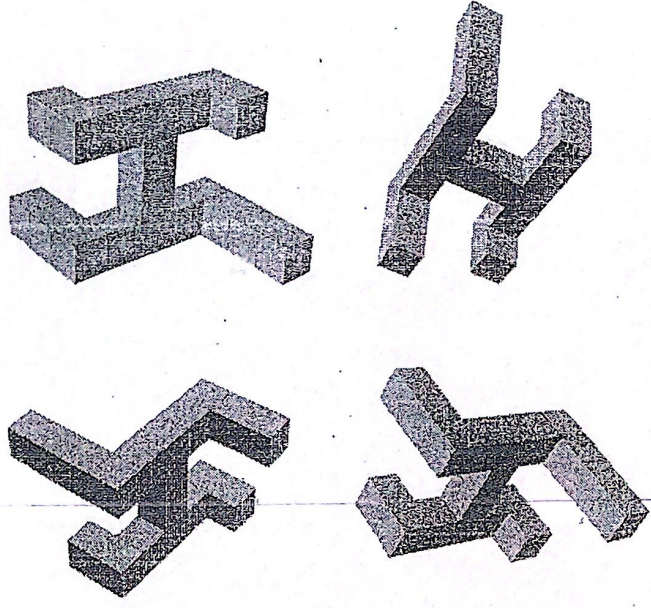

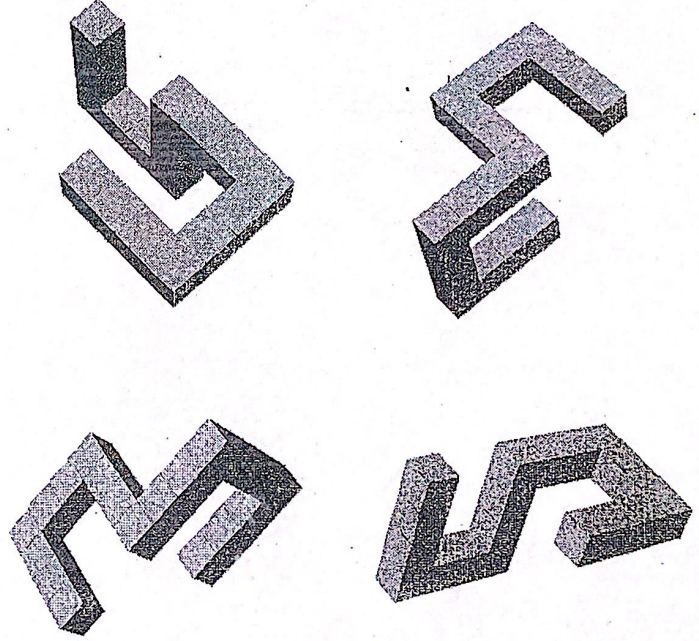







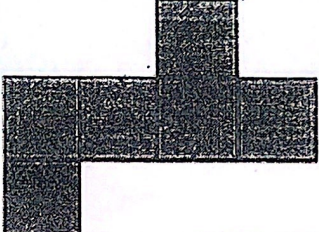

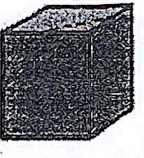
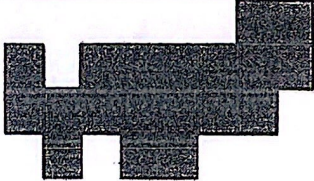
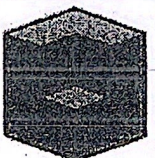
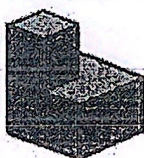
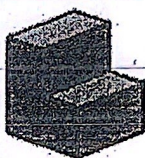

INDEX NO:

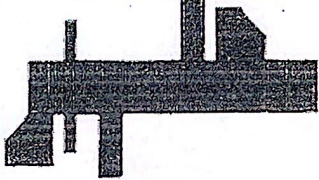
09		
10		

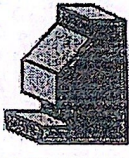

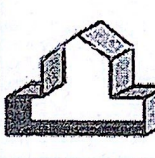
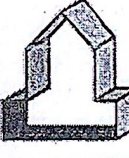

3.2 The templates given fold into a particular form. Select the correct form & Underline.

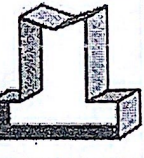
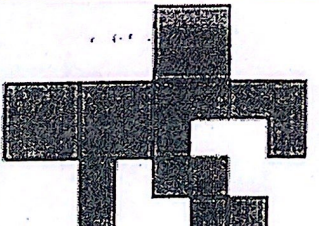
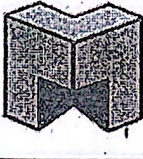
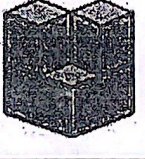
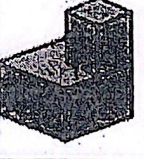
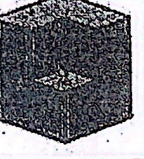
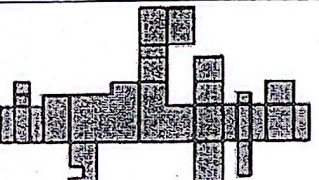
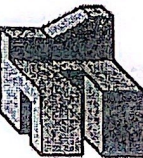
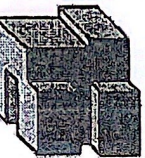
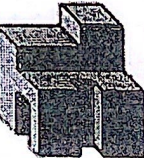
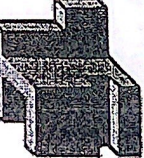
11					
12					
13					
14					
15					
16					





INDEX NO:

































17					
18					
19					
20					

3.3 Select the correct answer & Circle.

21	<p>          is rotated to          </p> <p>         as                  is rotated to     </p> <p> </p>	22	<p>          is rotated to          </p> <p>         as                  is rotated to     </p> <p> </p>
----	--	----	--





<p>23</p>	<p> is rotated to </p> <p>as  is rotated to</p> <p>    </p>	<p>24</p> <p> is rotated to </p> <p>as  is rotated to</p> <p>    </p>
<p>25</p>	<p> is rotated to </p> <p>as  is rotated to</p> <p>    </p>	<p>26</p> <p> is rotated to </p> <p>as  is rotated to</p> <p>    </p>

3.4 Select the correct answer & Circle. There maybe more than one which is exactly the same.

27

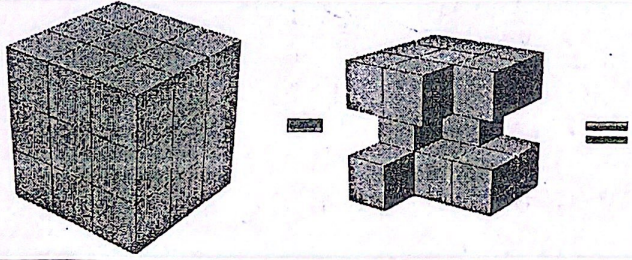

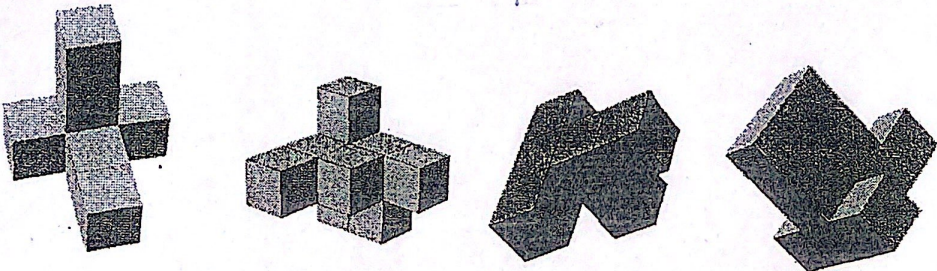



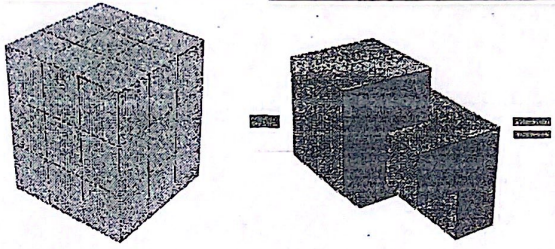
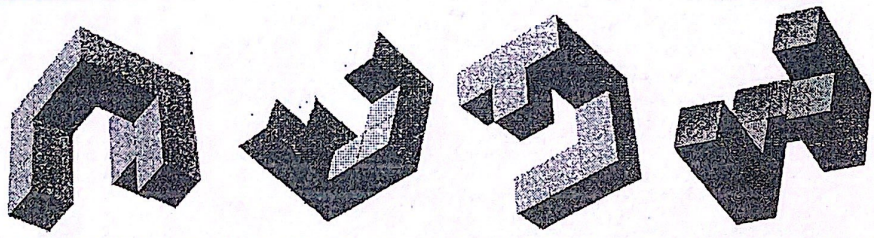
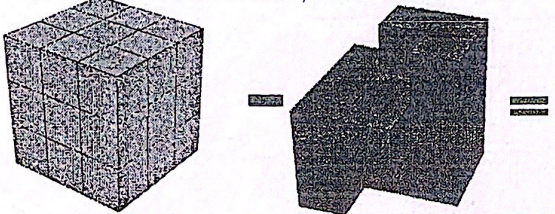
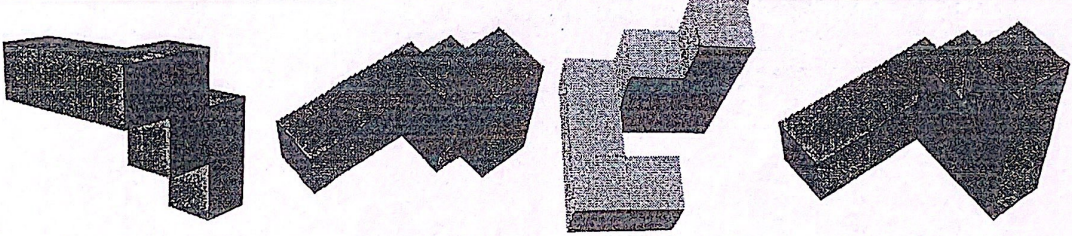
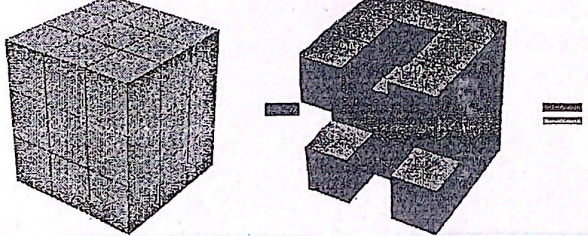
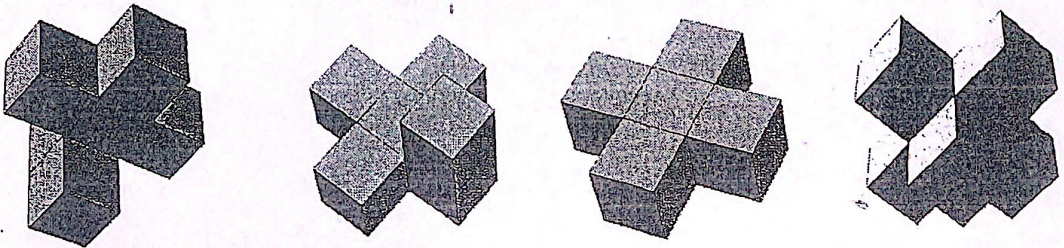

INDEX NO:

28	
	
29	
	
30	
	

STOP