

DEPARTMENT OF ARCHITECTURE
FACULTY OF ARCHITECTURE - UNIVERSITY OF MORATUWA

Aptitude Test for the Admission to the Bachelor of Architecture (B Arch) Degree & Bachelor of Landscape Architecture (B L A) Degree - 2014

(Three Hours) - 03 hrs

Instructions to candidates

1. Answer all **THREE** questions.
2. All questions to be answered in **ENGLISH** only.
3. All questions to be answered on the question paper itself.
4. Write your index number in all answer sheets.
5. Question No. 3 will be given **one hour** before the closing time.
6. **STOP** when instructed and place paper face down on your desks.

QUESTION ONE (20 MARKS)

Given are drawings of four chairs in Two Dimensions.

Re-draw each of the four chairs in Three Dimensions (**3D**) in the spaces given in page 2.

Propose a colour scheme for these chairs and colour your drawings accordingly.

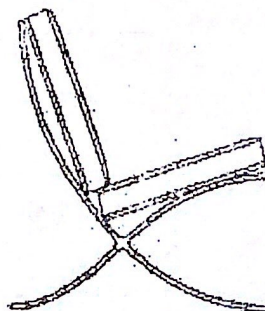
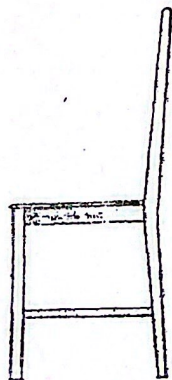
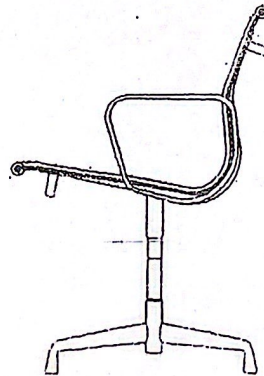
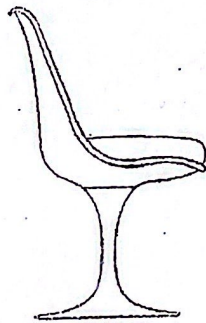

QUESTION TWO (50 MARKS)

You are the leader of a group of 12 undergraduate students, on a training exercise, during your leadership training programme. Your group has been assigned to a task of crossing a 3m deep river in two different locations.

None of your group members are allowed to swim across and you are asked to propose design solutions for each of these locations, which enable the group to cross the river safely.

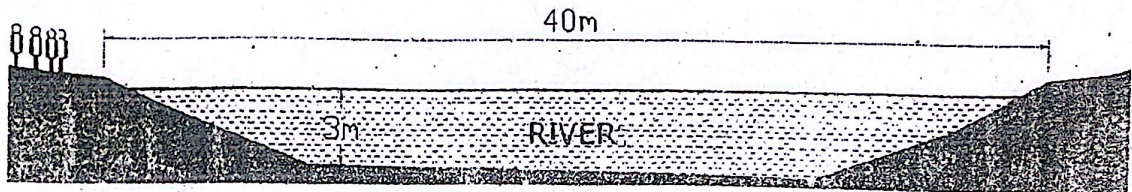
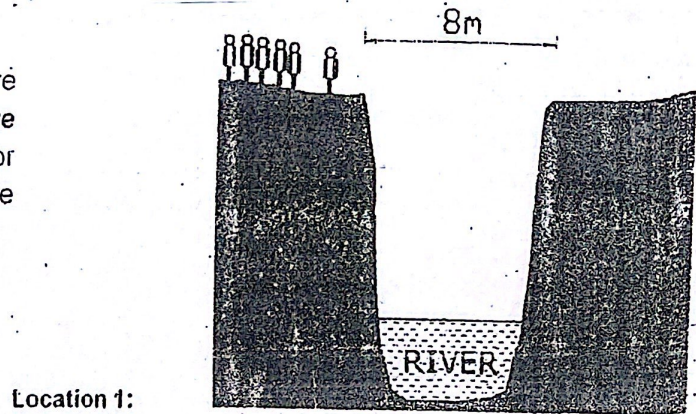

When formulating the solution, you can to use only the following resources, available for you at each location.

1. 6 units of 1500mm x 300mm size Timber planks
2. 6 units of 1000mm high x 600mm diameter, sealed metal Barrels.
3. 20 units of 6000mm long x 100mm diameter Bamboo Poles.
4. 10 units of 5000mm long Ropes.

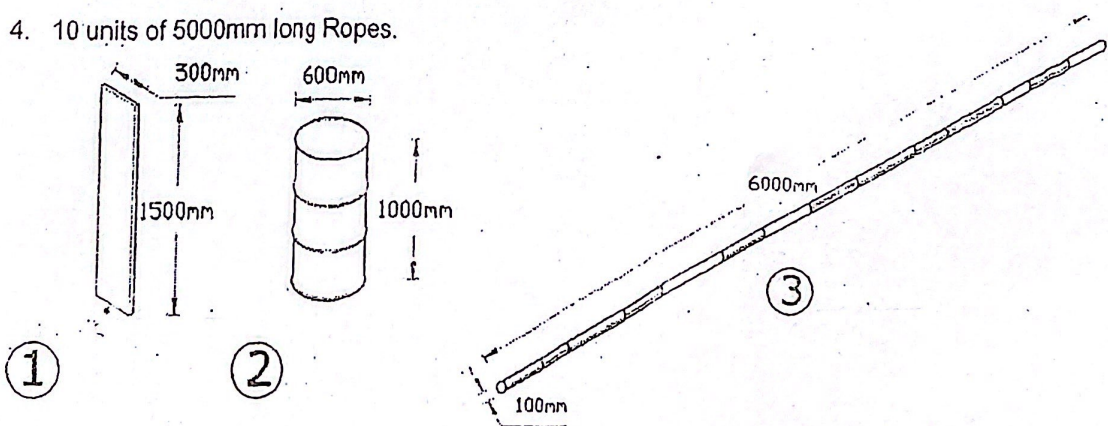

- 2.1 Explain both of your design solutions with three dimensional sketches in space provided on page 4. **(30 MARKS)**
- 2.2 Select one of those situations and draw a scene of your group crossing the river in space provided on page 5. You are expected to colour your drawing. **(20 MARKS)**



UNIVERSITY OF MORATUWA
PHOTO COPY SERVICES
2/1/2

INDEX NO.

20 M

B.L.H

B. Arch.

QUESTION THREE – 60 MINUTES (30 MARKS)



- o All questions need to be answered by **circling** the appropriate answer on the question paper itself
- o **STOP** when instructed and place paper face down on your desks

3.1

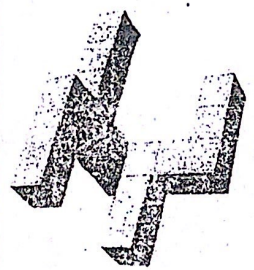
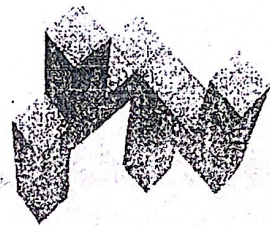
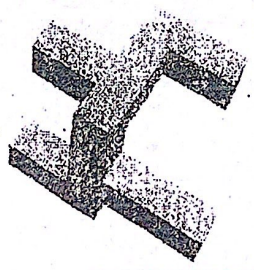
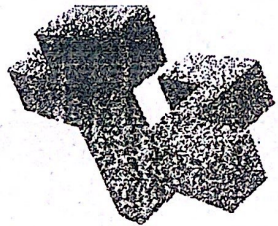
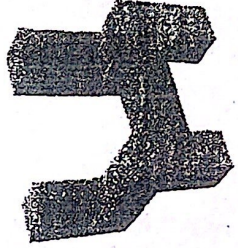
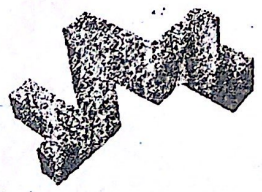
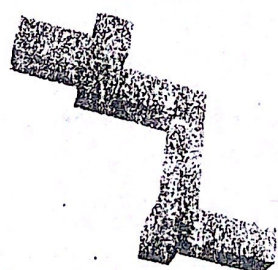
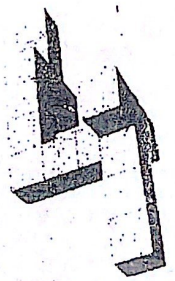
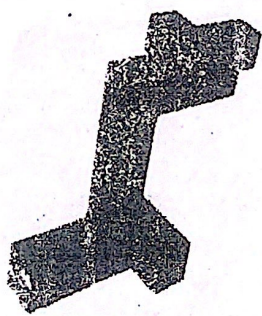
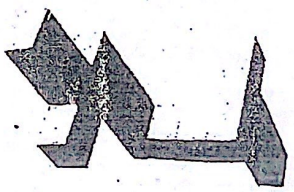



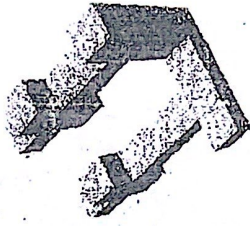
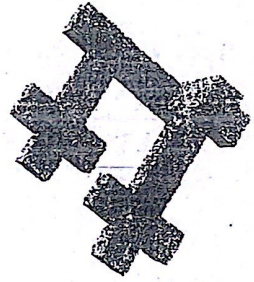
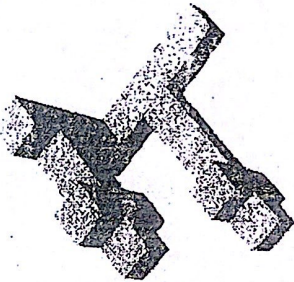
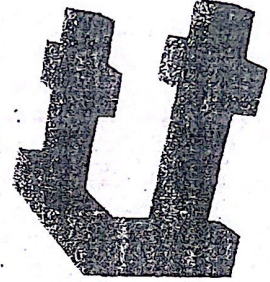
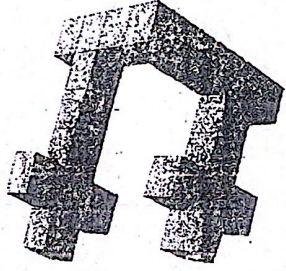
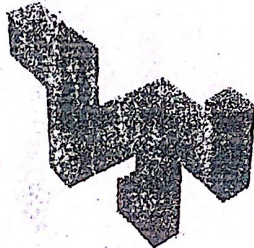
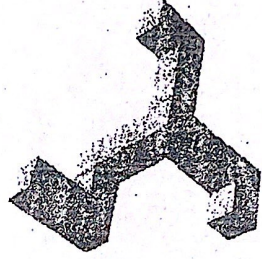
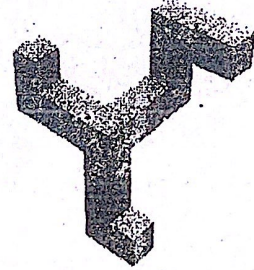
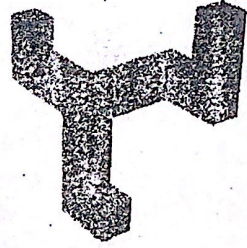
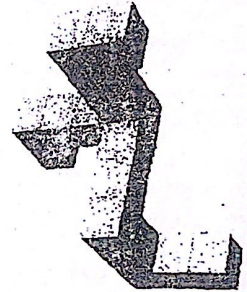
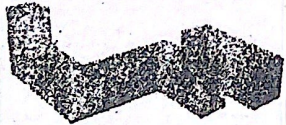

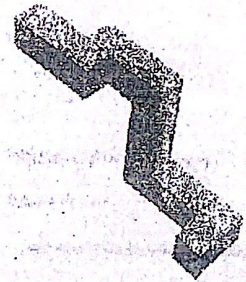
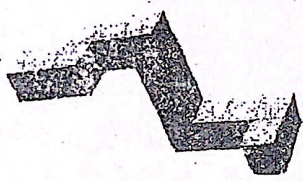
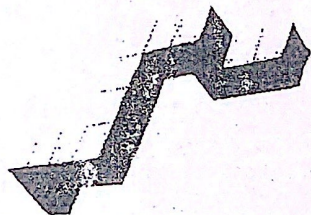

Identify the shape that is identical to the one on the **left**.
There maybe more than one which is exactly the same. Circle the correct answer/s.

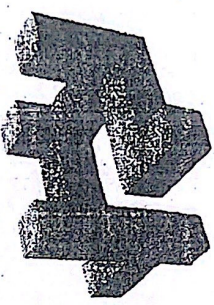
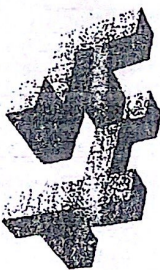
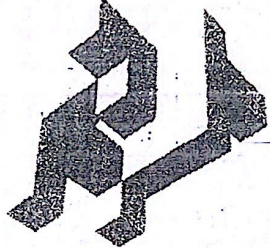
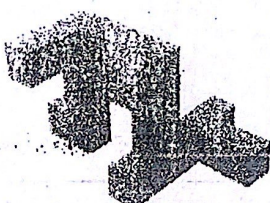
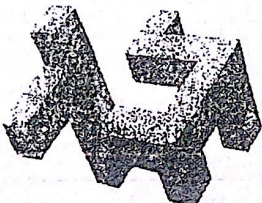
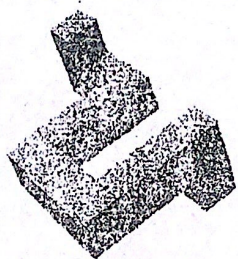
01		 	 
02		 	 

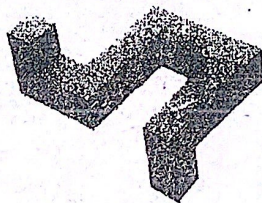

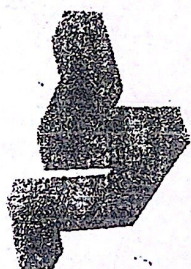

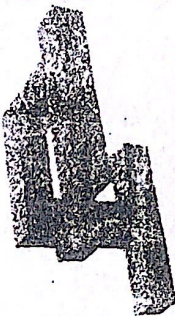
03		 	 
04		 	 
05		 	 

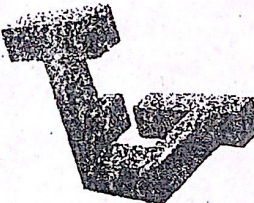
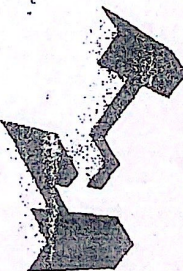

06		 	 
07		 	 
08		 	 

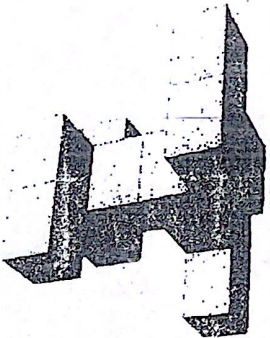
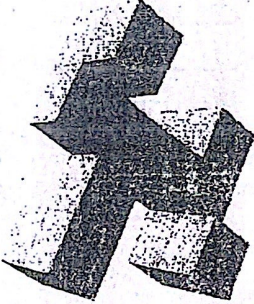

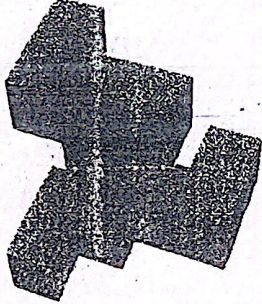
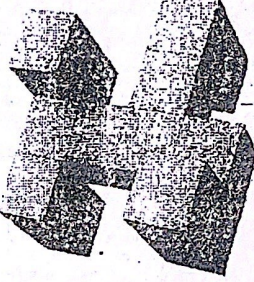
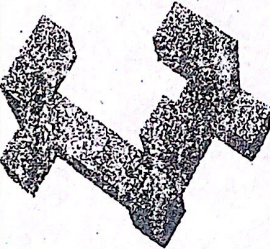
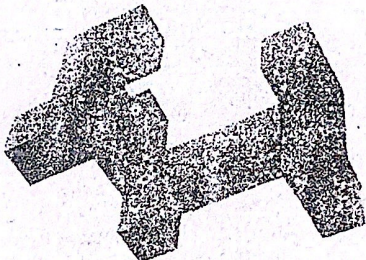
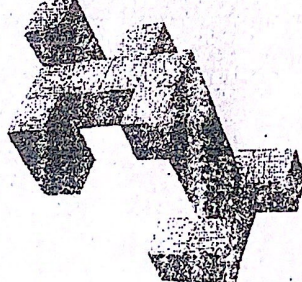
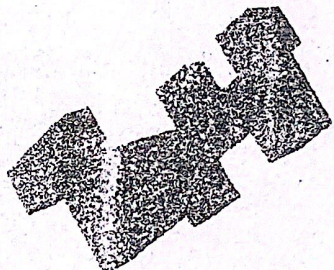
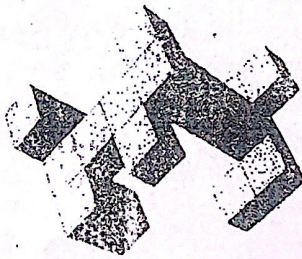
09		 	 
10		 	 



3.2 Select the correct answer & Circle: There maybe more than one which is exactly the same.

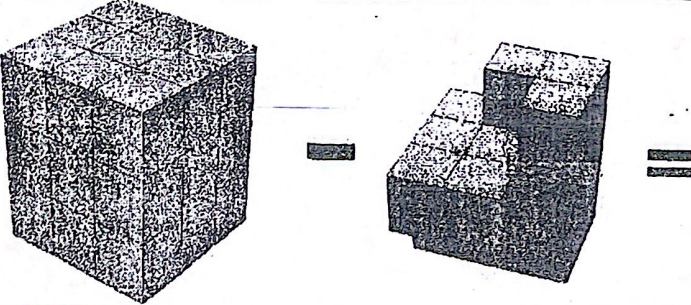
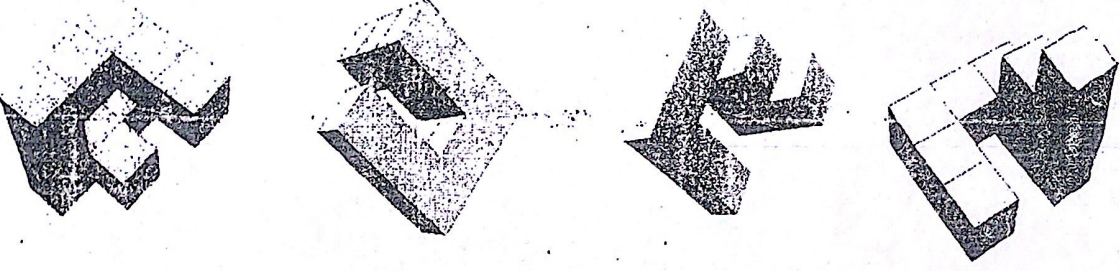
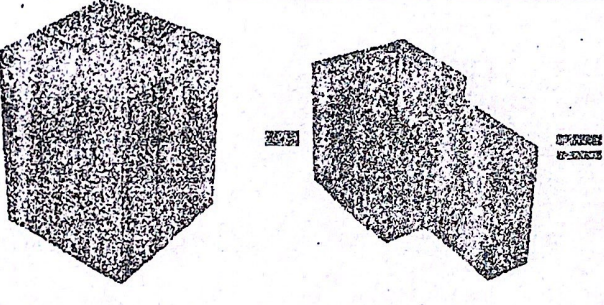
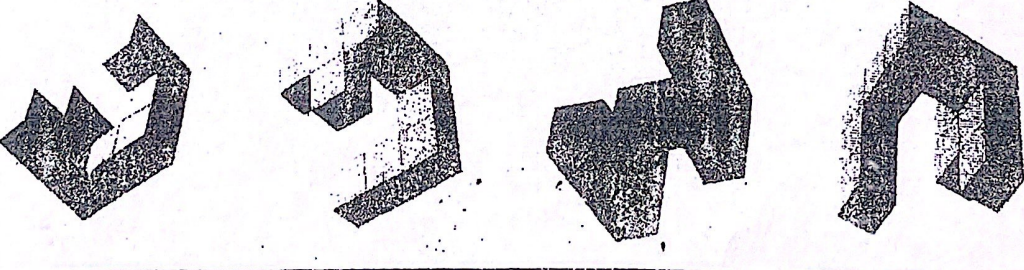
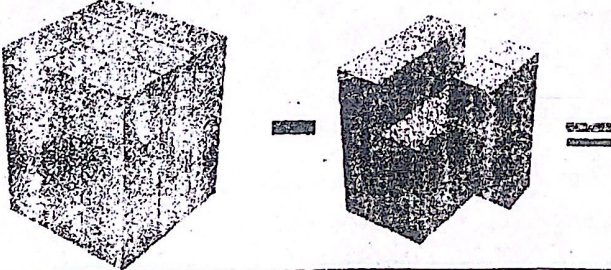
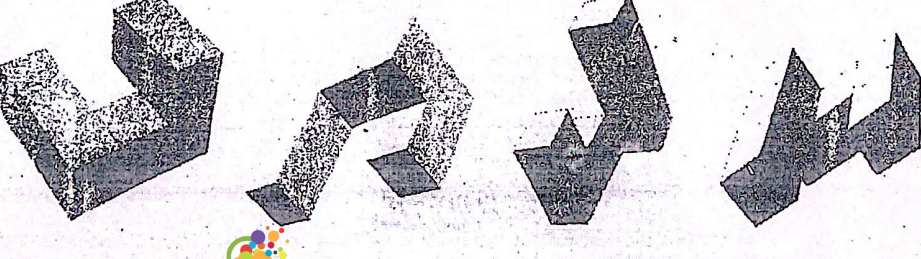

11	
	
12	
	
13	
	

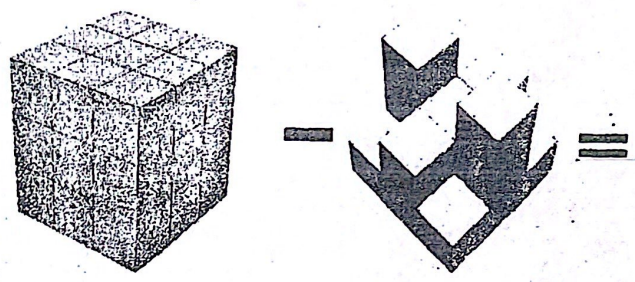
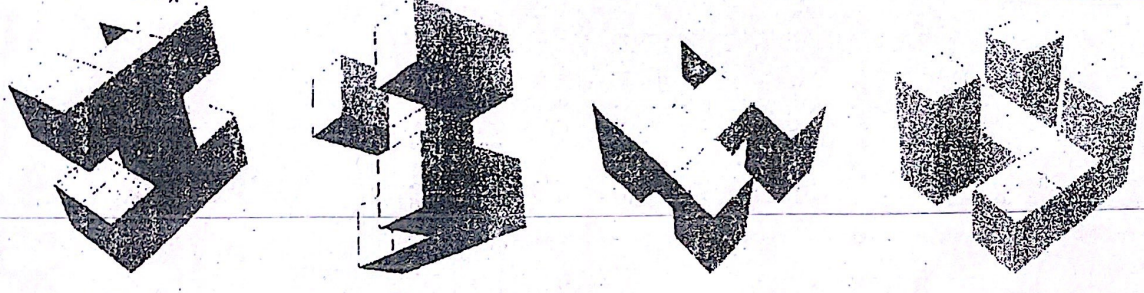
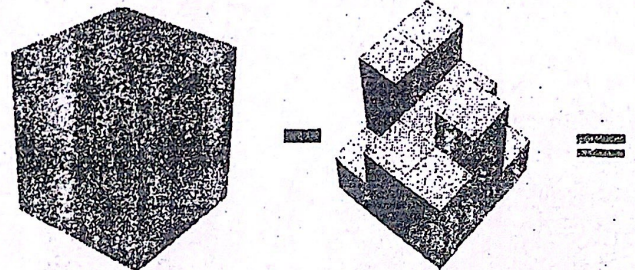
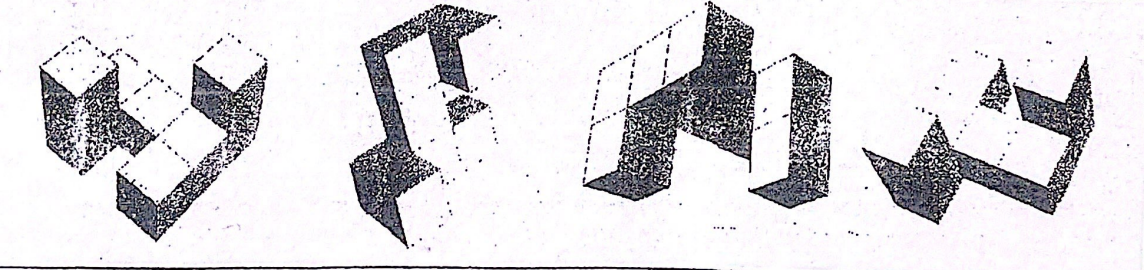
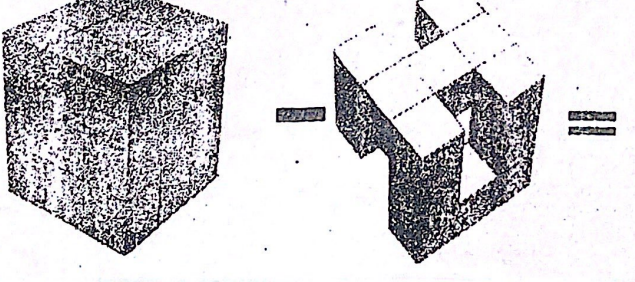
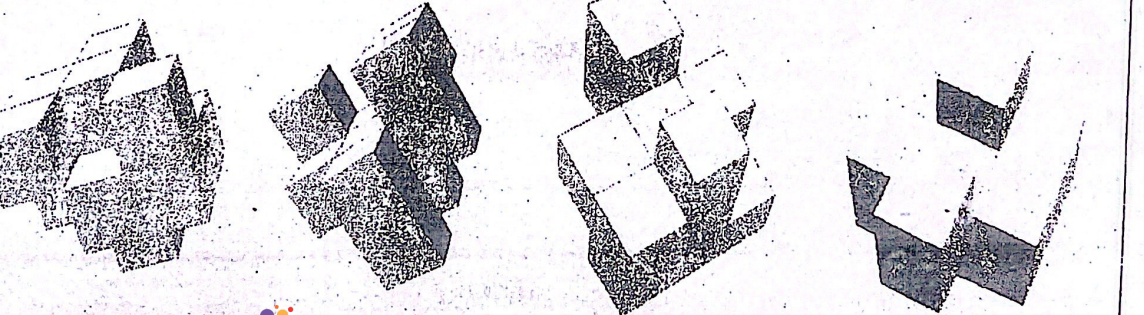

14	
	
15	
	
16	
	

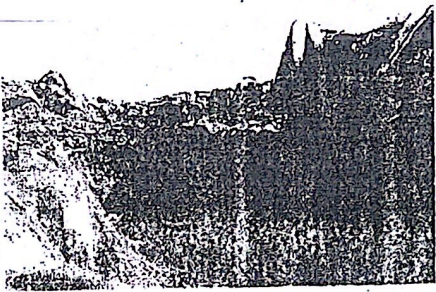
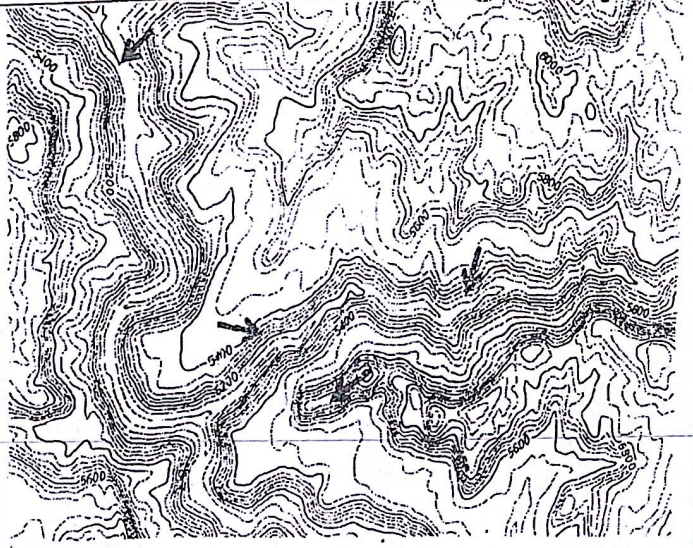
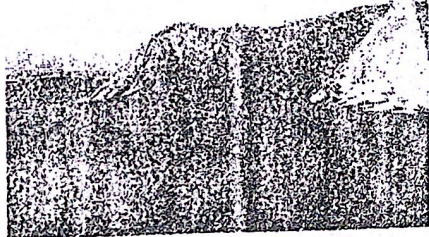

3.3 Imagine you see the view on the picture of the left hand side. Circle the correct arrow on the map that indicates where and which direction you think you are facing.

17		
18		
19	